



TUFF COUNTRY

EZ-RIDE SUSPENSION

INSTALLATION MANUAL

2.5" PERFORMANCE EXTENDED RADIUS ARMS.

1980 - 1996 F150 & BRONCO

PART # F2XRB

SJ060900

WARNING: TUFF COUNTRY EZ-RIDE SUSPENSION HIGHLY RECOMMENDS THAT A CERTIFIED

PART # : F2XRB
FORD F150 & BRONCO 1980 - 1996 2.5" PERFORMANCE EXTENDED RADIUS ARMS

PARTS LIST:

Qty.	Description	Part
1	Driver Side Extended Radius Arm	F2XRB-01
1	Passenger Side Extended Radius Arm	F2XRB-02
1	Driver Side Extended Radius Arm Drop Bracket	F2XRB-03
1	Passenger Side Extended Radius Arm Drop Brackets	F2XRB-04
1	Front Axle Pivot Bracket (Large)	F201
1	Rear Axle Pivot Bracket (Small)	F202
2	9/16" x 3 1/2" Cam Bolt	CAM-01
8	Cam Washers	CAM-02
2	9/16" x 4" Cam Bolt	CAM-03
4	9/16" Unitorque Nuts	916UN
1	Bushing & Sleeve Bag	XRBPB
1	Hardware Bag	F2XRB-NB
2	Sert Fittings	SERT
1	Instruction Sheet	F2XRB-INST

WARNING

If you desire to return vehicle to stock make sure to save all stock components

IMPORTANT CUSTOMER INFORMATION

This vehicle's reaction and handling characteristics may differ from standard cars and/or trucks. Modifications to improve and or enhance off road performance may raise the intended center of gravity. Extreme caution must be utilized when encountering driving conditions which may cause vehicle imbalance or loss of control. Drive Safely! Avoid abrupt maneuvers, such as sudden sharp turns, which could cause a roll over, resulting in serious injury or death.

It is the customer's responsibility to make sure a re-torque is performed on all hardware associated with this suspension system after the first 100 miles of installation. It is also the customer's responsibility to do a complete re-torque after every 1000 miles or after every off road use.

After the original installation, Tuff Country also recommends having the alignment checked every 6 months to ensure proper tracking, proper wear on tires and front end components. Tuff Country takes no responsibility for abuse, improper installation, or improper suspension maintenance.

IMPORTANT NOTICE

DO NOT install a body lift in combination with a suspension system. If a body lift is used in conjunction with any Tuff Country Suspension product, your Tuff Country **WARRANTY WILL BE VOID.**

NOTICE

It is the responsibility of the customer or the mechanic to wear safety glasses at all times when working with air tools.

Congratulations on your selection to purchase a Tuff Country Suspension System. We at Tuff Country are proud to offer a high quality product at the industries most competitive pricing. Thank you for your confidence in us, and our product.

***Important Notes:** Please read before beginning installation. OEM Manual should be used as a reference.

TUFF COUNTRY SUSPENSION highly recommends a qualified and or certified mechanic to perform this installation.

Check off parts list to be sure all parts are on hand. If any part is missing, you may call Tuff Country at: (800) 288-2190.

Read and understand all sections of instruction manual.

Use locktite on all bolts associated with this installation.

Torque Settings:

5/16"	15-18 ft. lbs.	3/8"	28-32 ft.lbs.
7/16"	30-35 ft. lbs.	1/2"	65-85 ft. lbs.
9/16"	75-90 ft. lbs	5/8"	85-110 ft. lbs.
3/4"	105-125 ft. lbs.		

Special Note: This box kit includes the bracket for the axle pivots, extended radius arms and radius arm drop bracket. The coils spring are sold as a separate part number, if you have not already done so part # F2CL needs to be ordered. Also if you have not already done so, Part # F2RB needs to be ordered. This is the box kit to lift the rear end.

Please Follow Instruction Carefully

Before installation begins, drive and check to make sure there are not any uncommon sounds and or frame damage. Also at this time measure from the center of the hub to the bottom of fender well and record measurements below.

Pre Installation Measurements:

Driver Side Front _____
Passenger Side Front _____
Driver Side Rear _____
Passenger Side Rear _____

At the end of the installation take the same measurements and compare to the pre installation measurements.

Post Installation Measurement:

Driver Side Front _____
Passenger Side Front _____
Driver Side Rear _____
Passenger Side Rear _____

Please following instructions carefully.

Front End Installation:

1. To begin installation, block the rear tires and safely raise front of vehicle with an air or hydraulic jack and place a pair of jack stands under frame. Place one jack stand on each side of vehicle.

2. Remove front tires and shocks.

3. Disconnect sway bar end link from bottom of frame. Save hardware for later re-installation. (If so equipped)

4. **Front axle pivot drop bracket installation:** Support axle by using a jack stand under front axle. Remove stock bolt that holds front axle into stock bracket and discard. Lower down on jack stand so that the front axle is lowered out of the stock bracket. Remove the front stock axle pivot bracket from frame and crossmember and discard. Save hardware for later re-installation. Locate part number F201 front axle pivot drop bracket (**large**). Install new front axle pivot drop bracket into stock holes using stock hardware.

Note: Make sure to use lock tight on these bolts.

Tighten all stock bolts at this point. (Torque to 85 ft. lbs.)
(See Illustration # 1)

5. Locate (1) 9/16" x 3 1/2" Cam Bolt, (2) Cam Washers and (1) 9/16" unitorque nut. Raise up on jack stand until the axle goes into the newly installed axle pivot bracket. Install new cam bolt and washers through new bracket and axle. Place the cam washer in the center position and tighten.

Note: Once the suspension system is complete take directly to an alignment shop, at this time the alignment shop will properly align your vehicle.

(See Illustration # 1)

6. **Rear axle pivot drop bracket installation:** Support the rear axle by using a hydraulic jack. Remove the stock axle pivot bolt that holds rear axle into the stock bracket and save for later re-installation. Lower down on hydraulic jack until the axle pulls away from the stock location. Locate part number F202 rear axle pivot drop bracket (**Small**), (1) 1/2" x 1 1/2" bolts, (2) 1/2" flat washers and (1) 1/2" unitorque nuts. Install the new axle pivot bracket into the stock location and secure using stock axle pivot bolt that was removed earlier in this step. (**Do not tighten at this point**). Make sure that the new axle pivot bracket is seating square in the stock pocket. Using the (1) hole in the new brackets as guides, drill (1) 1/2" hole in the crossmember. Secure using (1) 1/2" x 1 1/2" bolts, (2) 1/2" flat washers and (1) 1/2" unitorque nuts. Tighten the stock axle pivot bolt and the 1/2" hardware to 75 ft lbs.

(See Illustration # 2)

7. Locate (1) 9/16" x 3 1/2" Cam Bolt, (2) Cam Washers and (1) 9/16" unitorque nut. Raise up on jack stand until the axle goes into the newly installed axle pivot bracket. Install new cam bolt and washers through new bracket and axle. Place the cam washer in the center position and tighten.

Note: Once the suspension system is complete take directly to an alignment shop, at this time the alignment shop will properly align your vehicle.

(See Illustration # 2)

8. **Removing the stock coil springs:** Place a hydraulic jack stand under the front axle. On the driver side remove the lower 1 1/8" retaining nut and washer. Save hardware for later re-installation. Remove the upper coil spring retaining clip, also save for later re-installation. Remove coil spring and discard. Repeat procedure on passenger side.

9. **Stock Radius Arm & Stock Radius Arm Drop Bracket:** On the driver side, place a hydraulic jack under the middle of the stock radius arm. Drill or chisel off frame rivets and remove the stock bolts from the stock radius arm. Repeat procedure on passenger side.

(See Illustration # 3 / Illustration # 3 is showing the passenger side of vehicle)

10. On the driver side, remove the stock coil retaining bolt, which is located on the top of the axle. Next, remove the bottom stock axle housing bolt. **(Save these bolts for later re-installation)**. Remove the stock radius arm and stock radius arm drop bracket and discard. **Note: Stock radius arm and stock radius arm drop bracket are not used in this system and can be discarded.** Repeat procedure on passenger side.

11. On the **SIDE** of the driver side frame find the rear hole where the stock radius arm drop bracket was located. Measure back towards the rear of the vehicle 15". Make a mark on the side of the frame.

(See Illustration # 4)

12. Locate part number F2XRB-03, Driver side extended radius arm drop bracket. Place the bracket flush to frame as shown in illustration # 5. Line up the rear hole on the new bracket with the with the mark that was made in step # 11. Using a pair of "C" channel vise grips secure bracket to frame.

13. Using the new driver side extended radius arm drop bracket as a guide drill (4) 1/2" holes into frame. **(Two on the side of frame and two on the bottom)** Locate (4) 1/2" x 1 1/2" bolts (8) 1/2" flat washers and (4) 1/2" unitorque nuts. Secure new bracket to frame secure using 1/2" hardware. Torque to 75 ft lbs.

(See Illustration # 5)

14. On the **SIDE** of the passenger side frame find the rear hole where the stock radius arm drop bracket was located. Measure back towards the rear of the vehicle 15". Make a mark on the side of the frame. **Remember that the illustration # 4 is on the driver side, so the picture will look opposite when working on the passenger side.**

(See Illustration # 4)

15. Locate part number F2XRB-04, Passenger side extended radius arm drop bracket. Place the bracket flush to frame as shown in illustration # 5. Line up the rear hole on the new bracket with the with the mark that was made in step # 14. Using a pair of "C" channel vise grips secure bracket to frame.

16. Using the new passenger side extended radius arm drop bracket as a guide drill (4) 1/2" holes into frame. **(Two on the side of frame and two on the bottom)** Locate (4) 1/2" x 1 1/2" bolts (8) 1/2" flat washers and (4) 1/2" unitorque nuts. Secure new bracket to frame secure using 1/2" hardware. Torque to 75 ft lbs. **Remember that the illustration # 4 is on the driver side, so the picture will look opposite when working on the passenger side.**

(See Illustration # 5)

17. Locate part number F2XRB-01, Driver side extended radius arm. From poly/sleeve bag marked XRBPL locate (2) MO2050, (1) 916218SLWH and (1) sert fitting. Insert sert fitting into the end of the new driver side extended

radius arm. **(Hole already provided)** This sert fitting is a pound in fitting. Using a moly or lithium base grease, lube the two piece bushing and insert it into the end of the extended radius arm. Place crushed sleeve into the bushings.

18. Install new driver side extended radius arm into stock location on axle. Secure using stock coil retaining bolt and stock axle housing bolt.

(See Illustration # 6)

19. Locate (1) 9/16" x 4" cam bolt, (2) cam washers and (1) 9/16" unitorque nut. Working on the driver side raise up on jack until newly installed extended radius arm slides up into the newly installed radius arm drop bracket. Secure using 9/16" x 4" cam bolt. Place the cam washer in the center position and tighten. **Note: Once the suspension system is complete take directly to an alignment shop, at this time the alignment shop will properly align your vehicle.** Repeat procedure on passenger side.

(See Illustration # 7)

Installation of the front coil spring: The coil springs are not included in this box kit, if you have not already done so Part # F2CL needs to be ordered.

20. Working on the driver side install new coil spring into the stock location and secure using stock hardware. Make sure to re-install the upper coil clip. Repeat procedure on passenger side.

If you vehicle is not equipped with a stock front sway bar, installation is complete. Re-install tire and wheels and take directly to an alignment shop. If you vehicle is equipped with a stock front sway bar follow step # 21 for installation.

21. Re-install stock sway bar into stock location using stock hardware. **Note: if you are not able to install stock sway bar to the stock location the weight of the vehicle may need to be on the vehicle.**

**Congratulations Installation Complete
Take vehicle directly to an alignment
shop for proper alignment.**

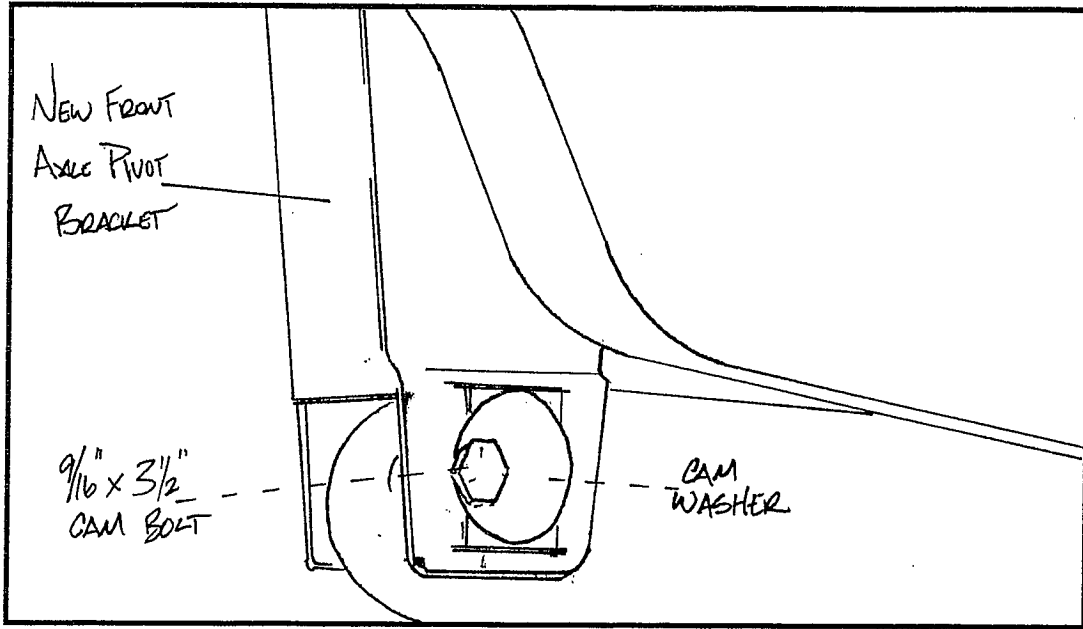

ILLUSTRATION # 1

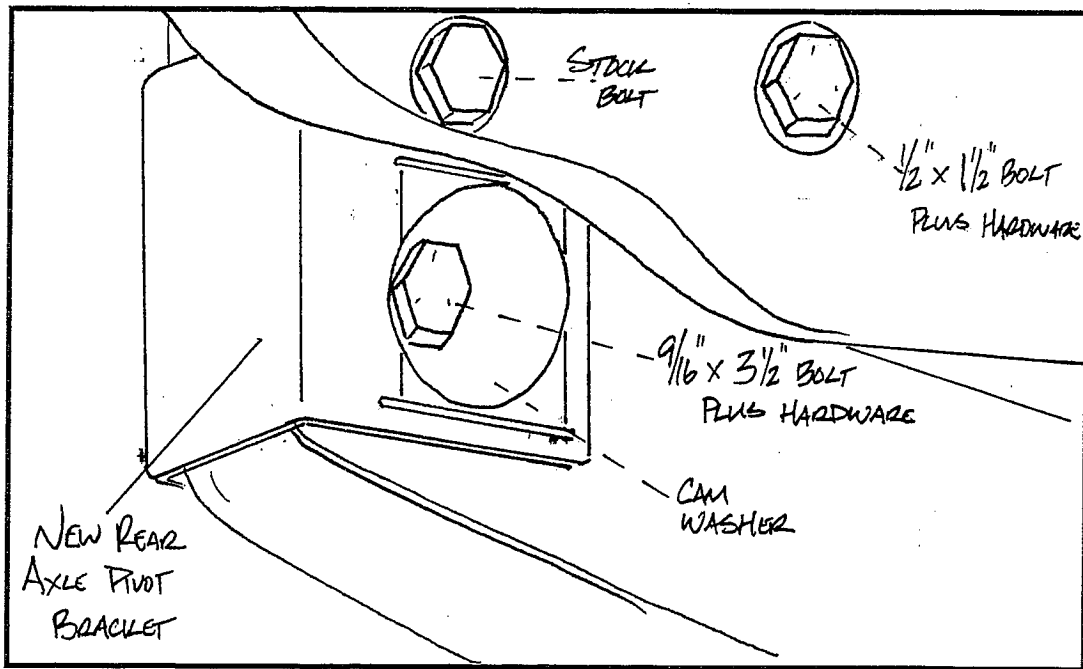

ILLUSTRATION # 2

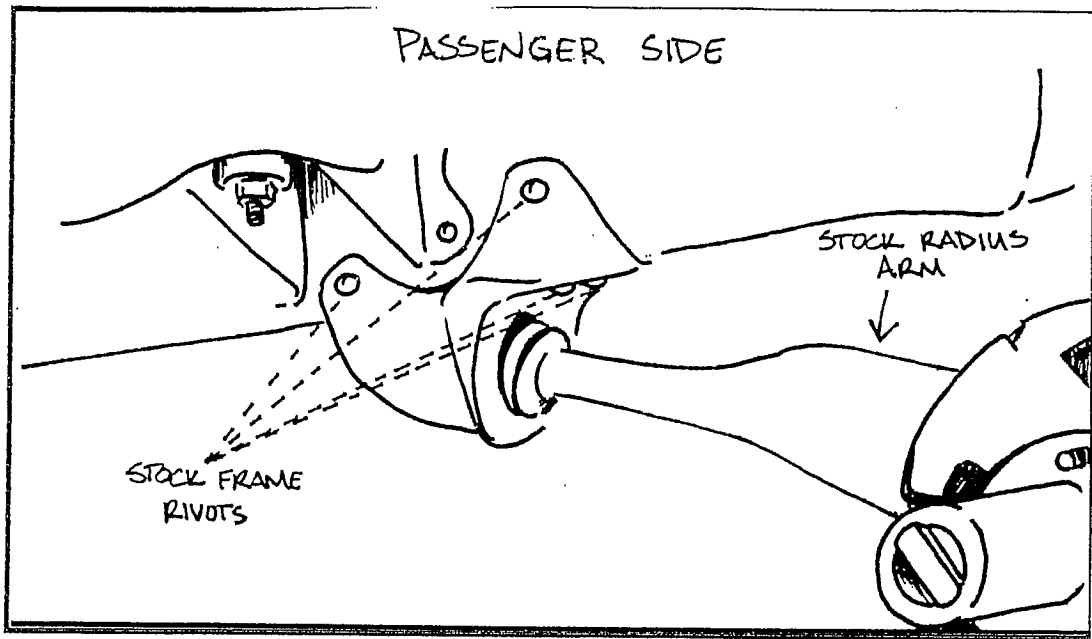

ILLUSTRATION # 3

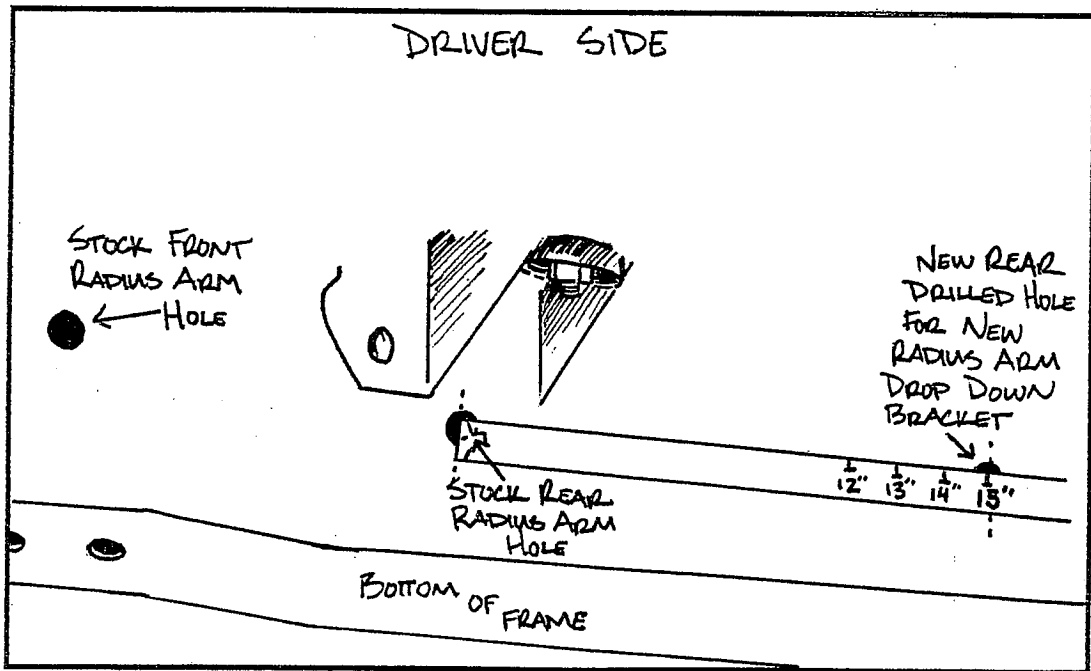

ILLUSTRATION # 4

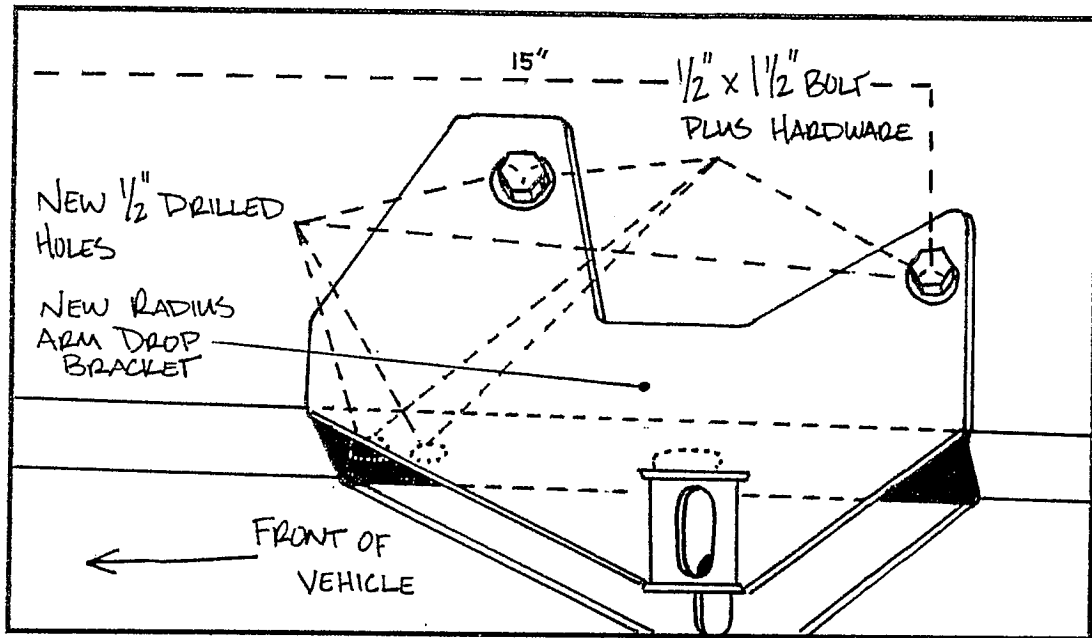

ILLUSTRATION # 5

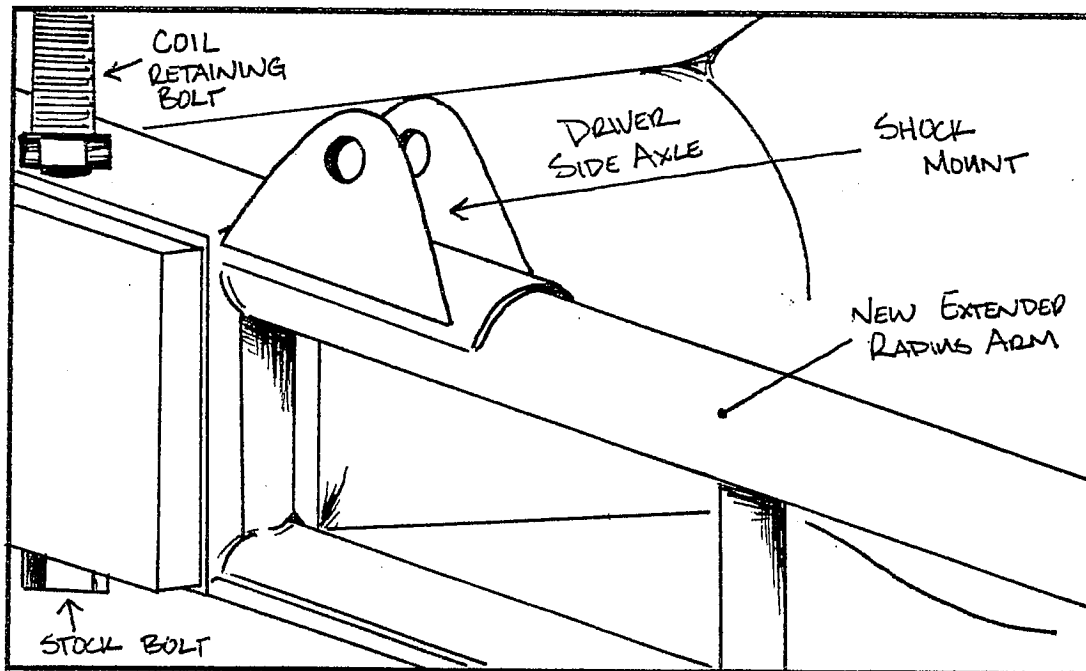

ILLUSTRATION # 6

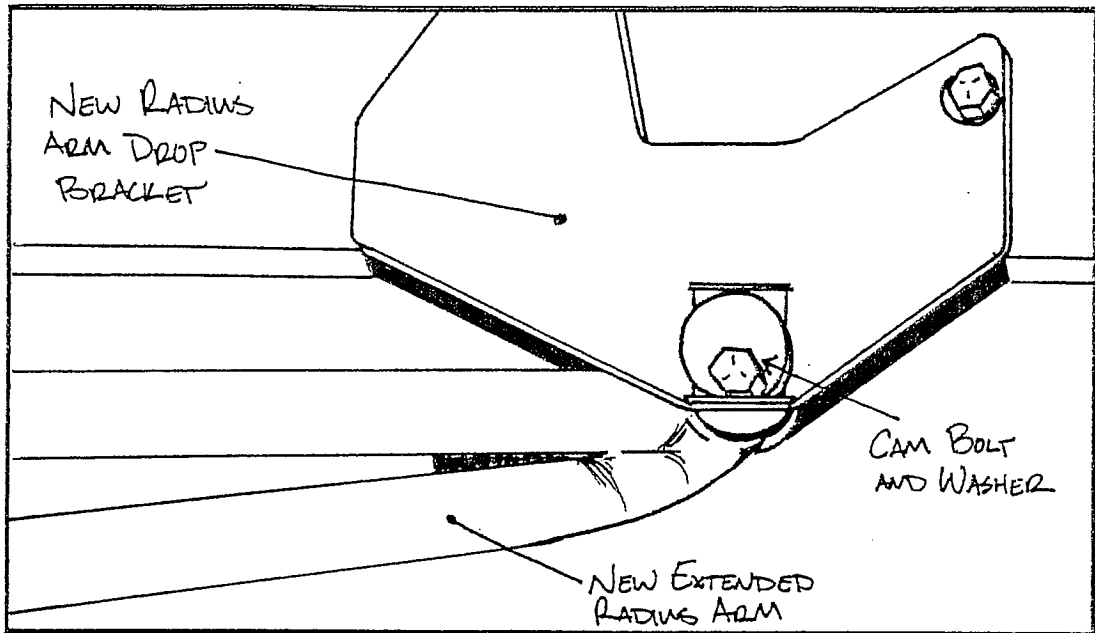

ILLUSTRATION # 7